

1

2

3

4

5

JST SMR-03V-B

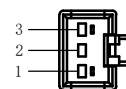
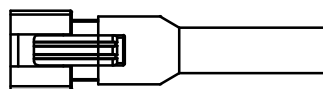

芯数

定义

1

正

2

空

3

负

延长线型号 SM24-Lx (x代表线长: 1/3/5)

unit: mm

A

B

C

D

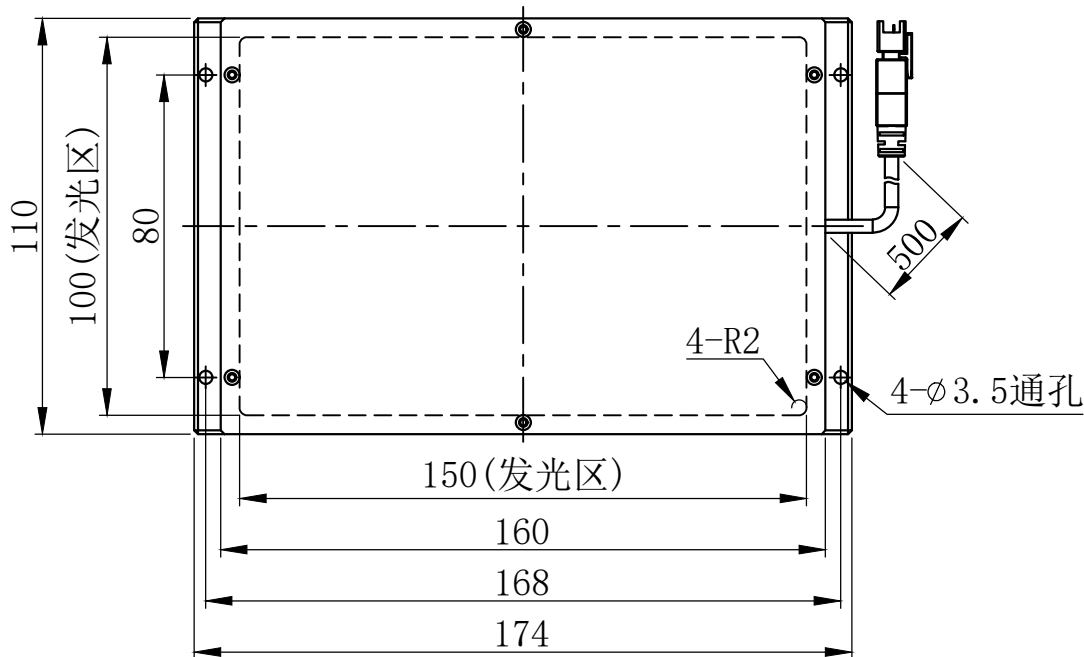
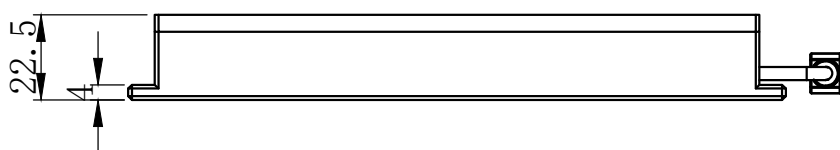

E

设计者	尺寸图版本号	1.0	型号	CRT-PFLD150100		产品安装尺寸图	
曾工	日期	2021-11-17	品名	平行面光源			
			比例	1:2	重量		

