

1

2

3

4

5

JST SMR-03V-B



芯数

定义

1

正

2

空

3

负

延长线型号 SM24-Lx (x代表线长: 1/3/5)

unit: mm

A

B

C

D

E

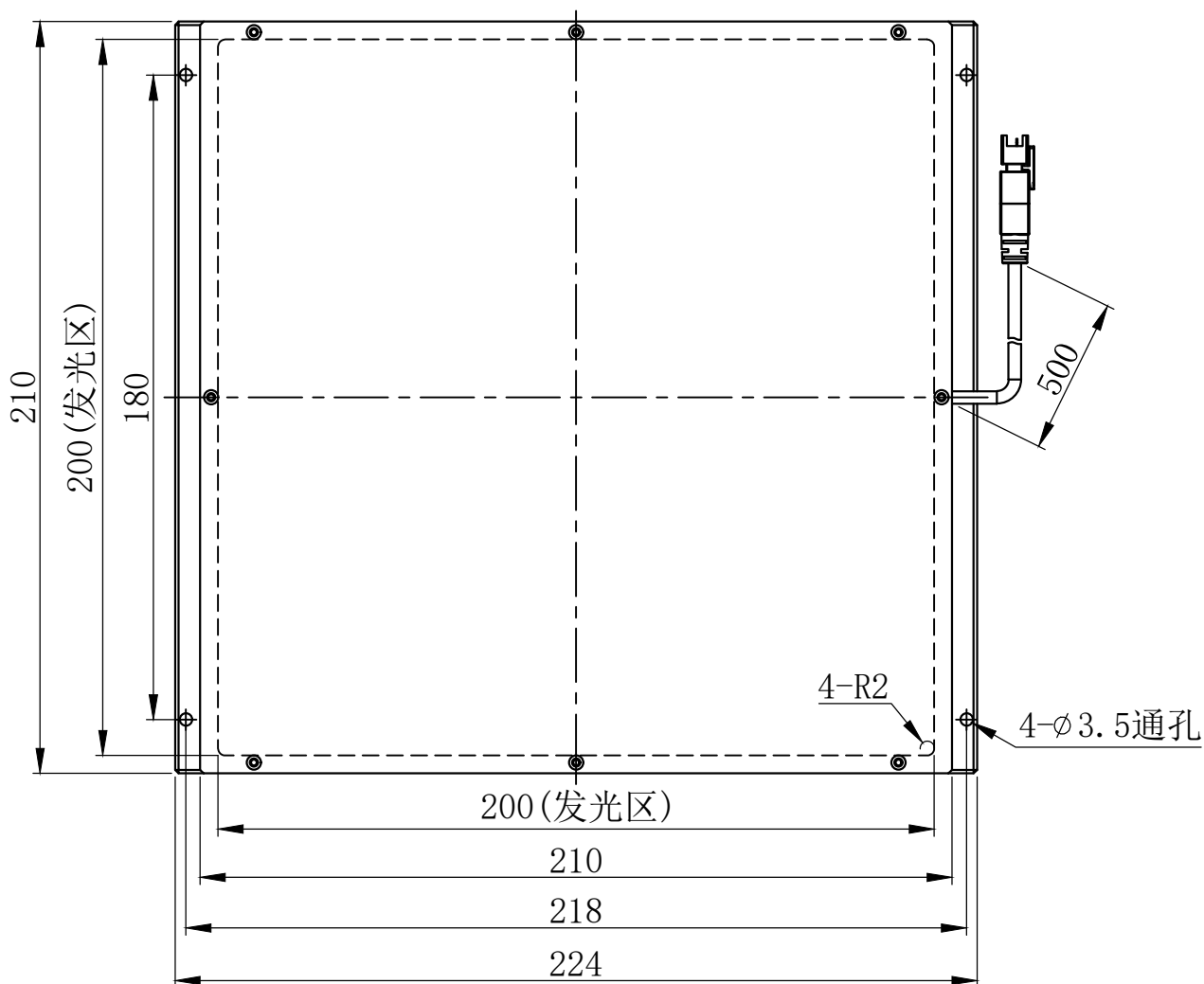
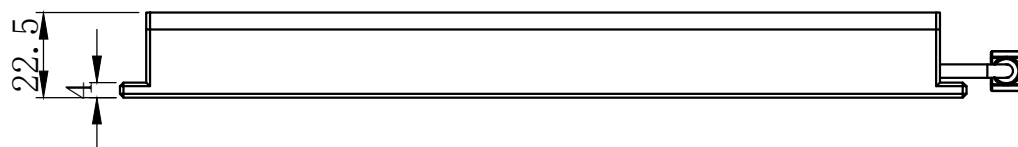

设计者

尺寸图版本号

1.0

型号

CRT-PFLD200200

产品安装尺寸图

曾工

日期

2021-11-19

品名

平行面光源



比例

1:2

重量

CRLED