

1

2

3

4

5

JST SMR-03V-B

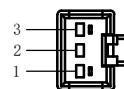
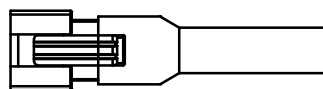

芯数

定义

1

正

2

空

3

负

延长线型号 SM24-Lx (x代表线长: 1/3/5)

unit: mm

A

B

C

D

E

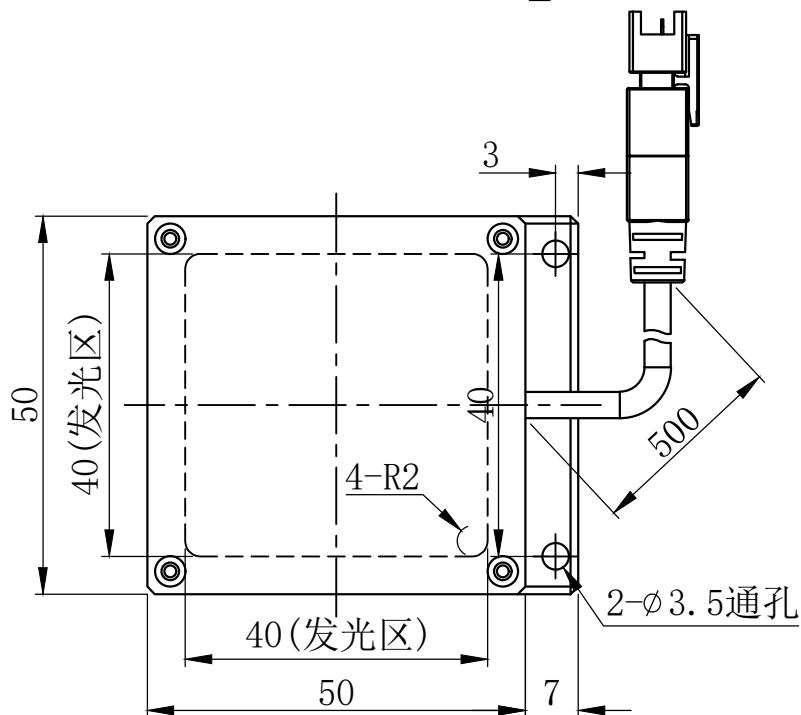
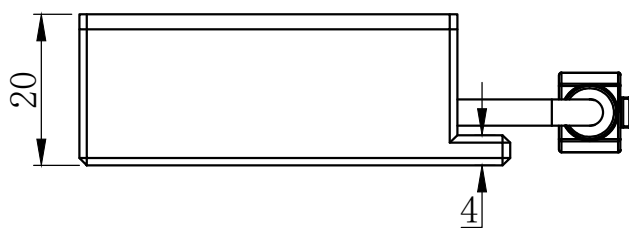

设计者

尺寸图版本号

1.0

型号

CRT-FLD4040

产品安装尺寸图

曾工

日期

2021-11-17

品名

面光源



比例

1:1

重量

CR LED